

Assembly Instruction

Step 6

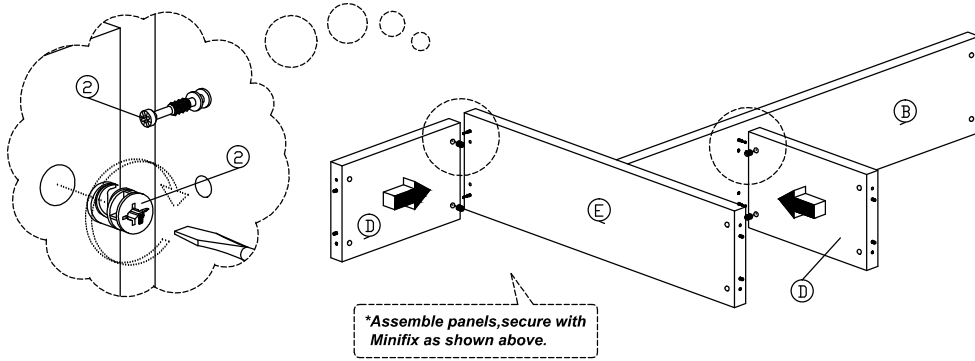

Step 7

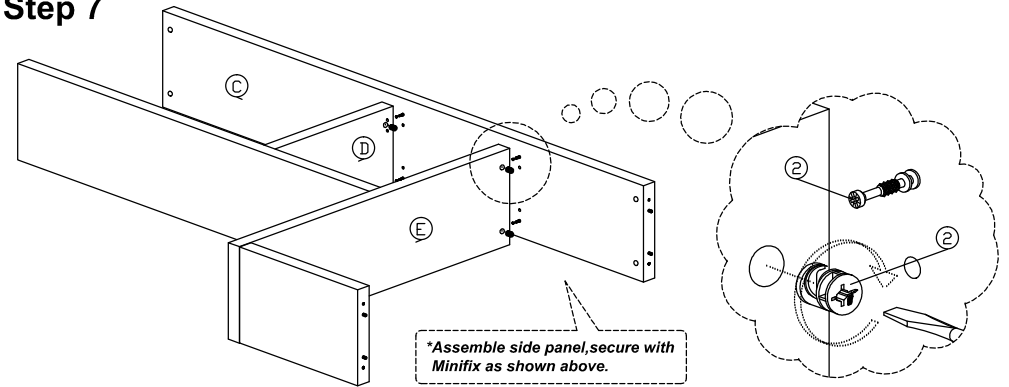

Step 8

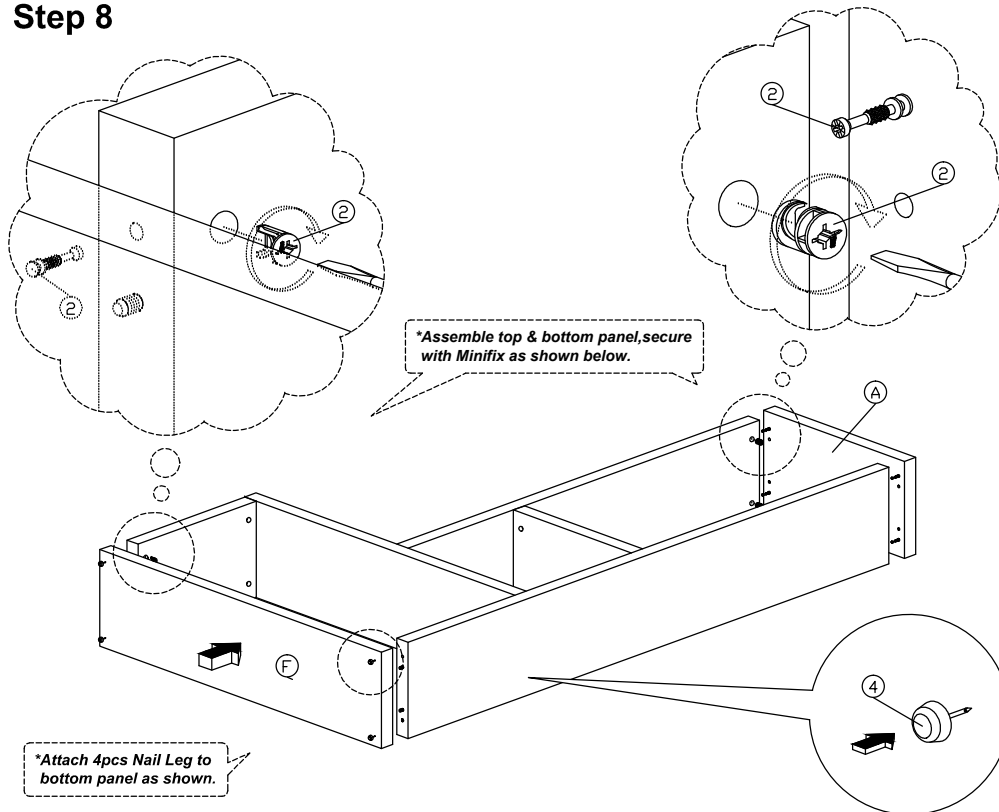

Step 9

